

Back thickness  
2.5mm

# Robert O'Brien's Classical Guitar Bridge Specifications

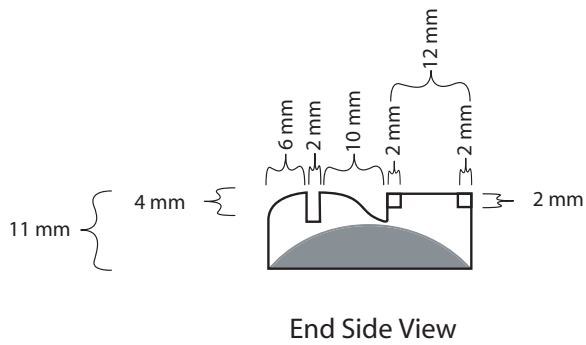
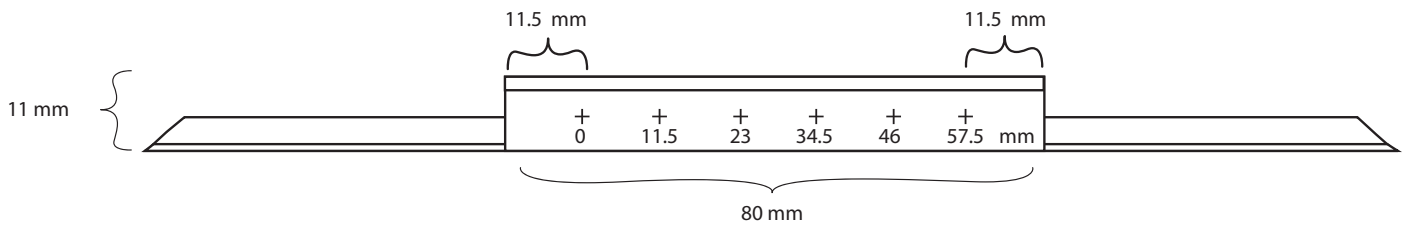
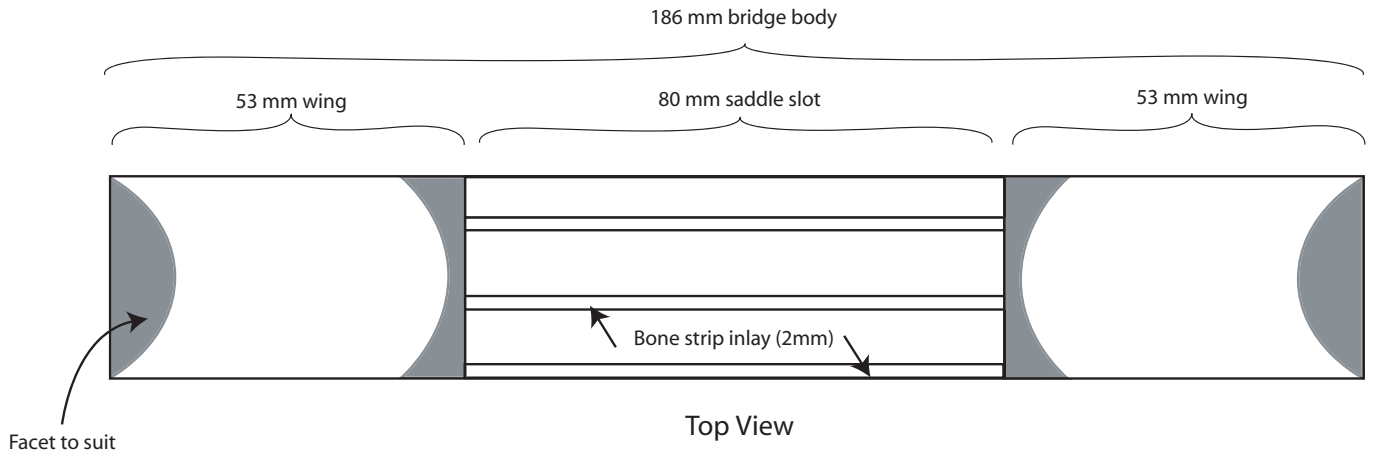

The bottom of the bridge is curved by approximately 2 mm. in the center graduating to 0 mm at the ends to match the curvature of top.

There is a taper of 1 mm. from the bass side to the treble side. The bass side is higher.

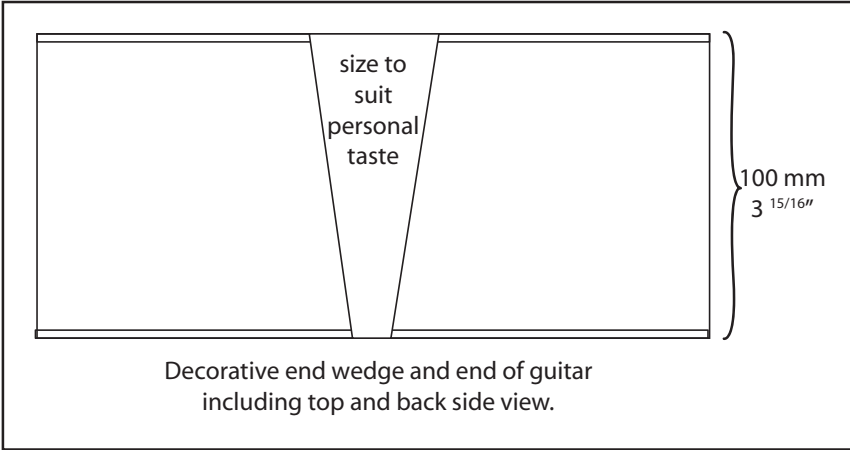
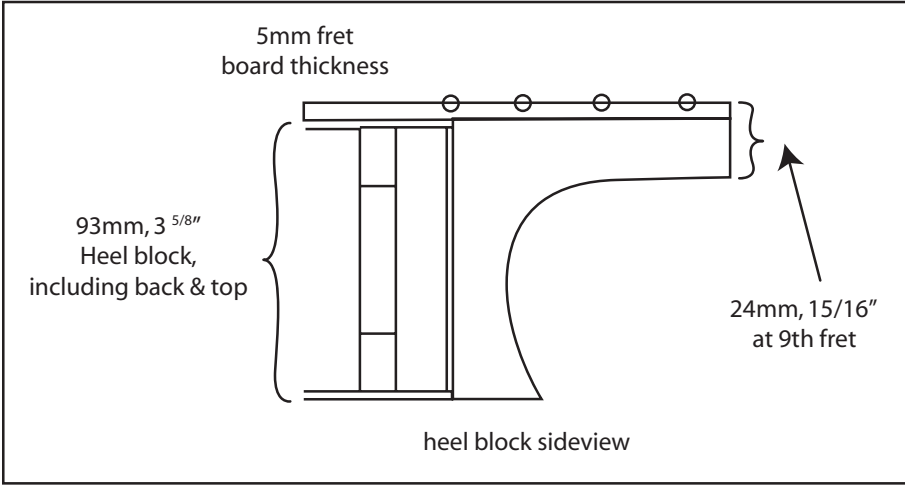
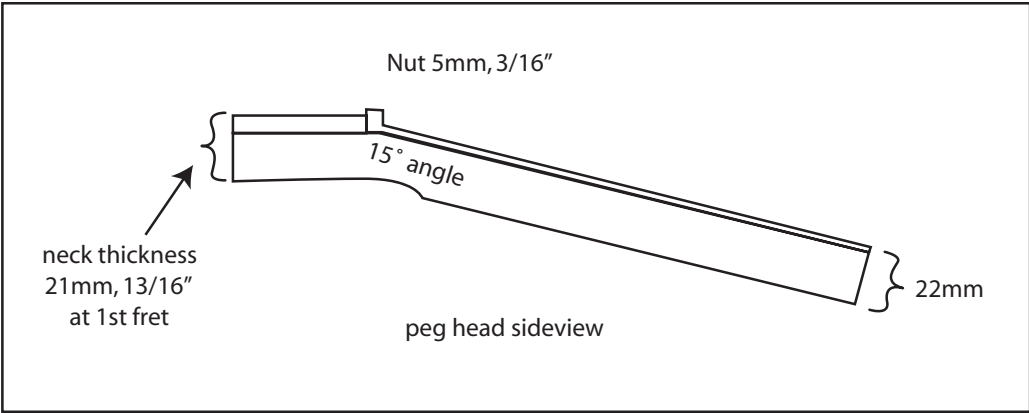
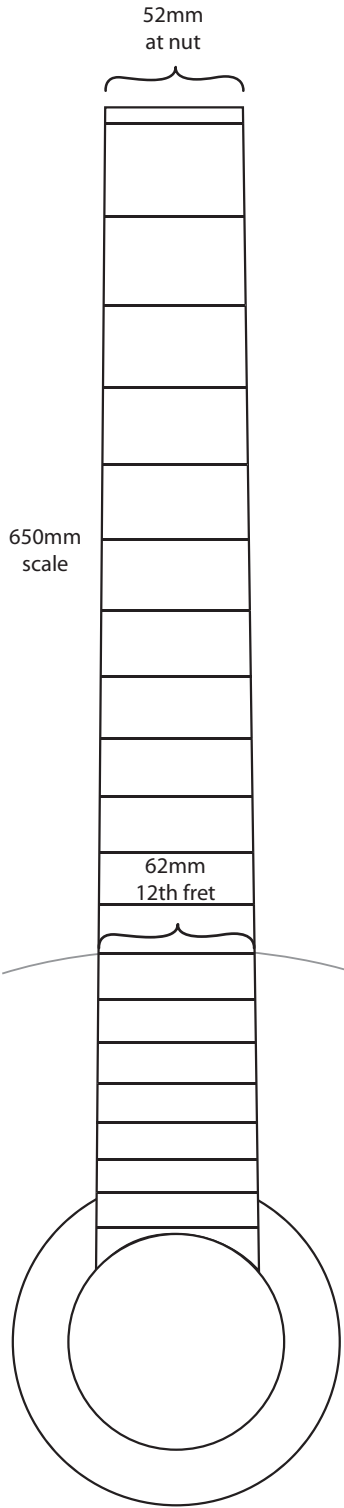

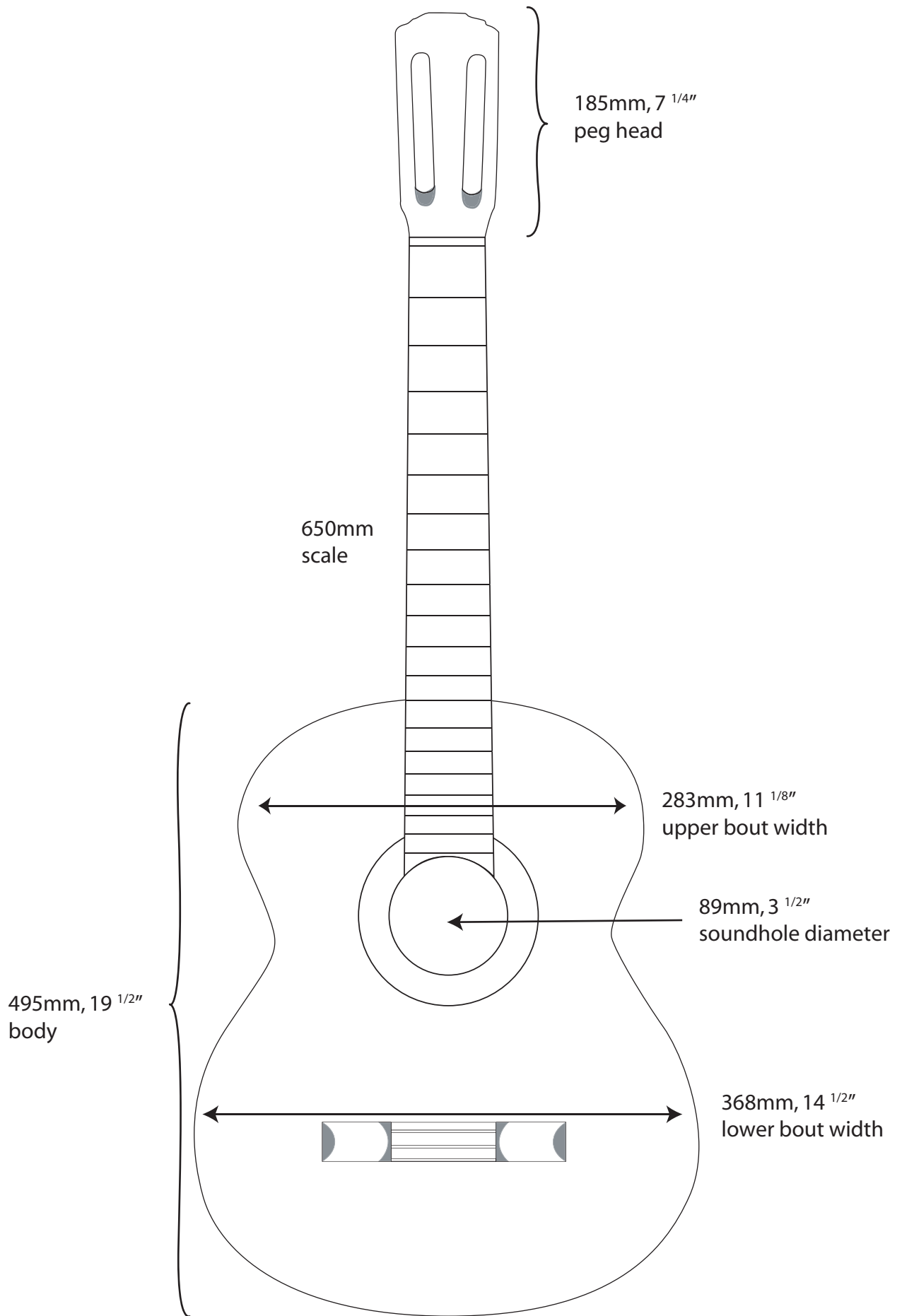

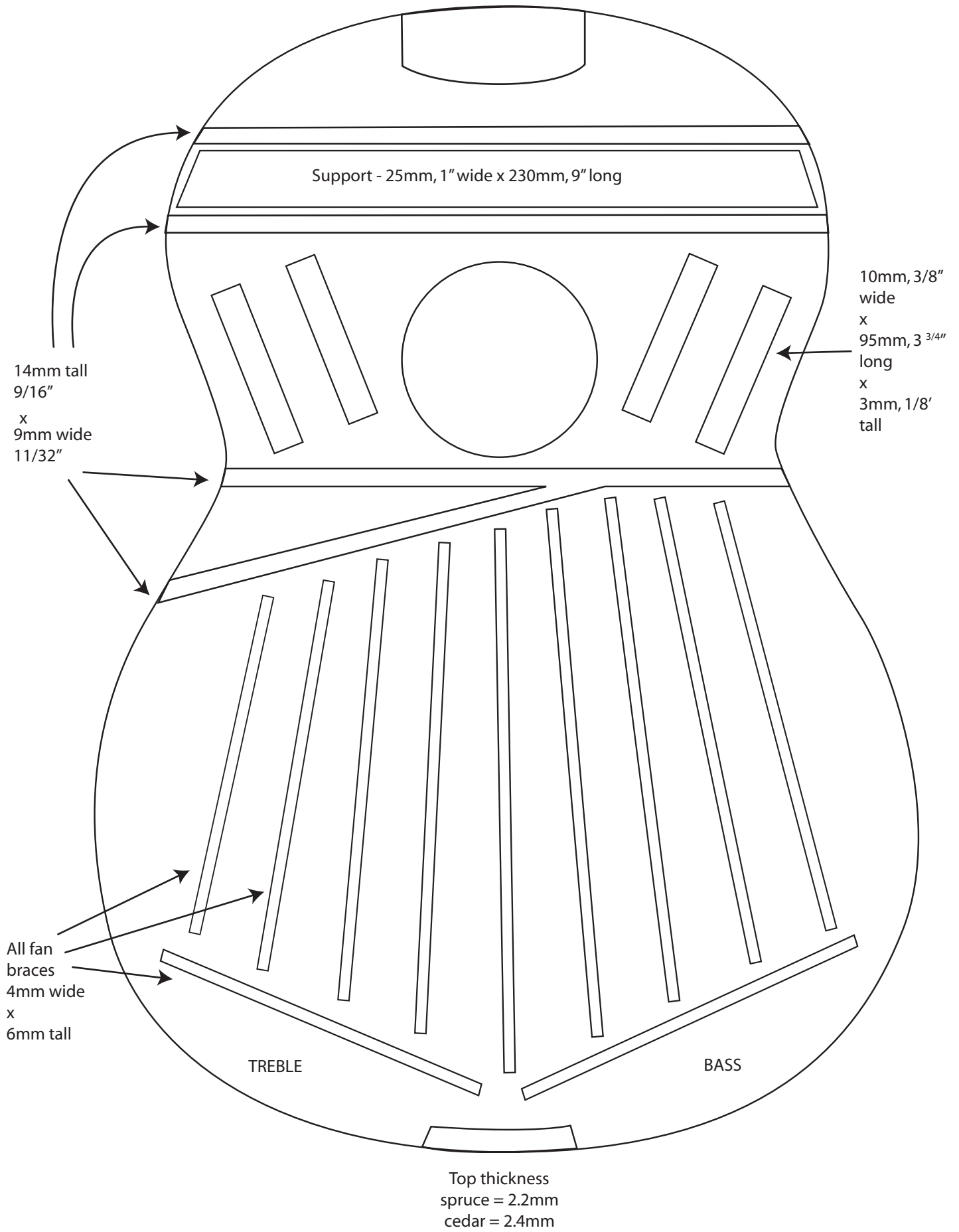

## Conversion Chart inch to mm to convert fractional and/or decimal inches to metric mm or vice versa

Inches Fractional	Metric Decimal	mm	Inches Fractional	Metric Decimal	mm
.	0.0039	0.1000	27/64	0.4219	10.7156
.	0.0079	0.2000	.	0.4331	11.0000
.	0.0118	0.3000	7/16	0.4375	11.1125
1/64	0.0156	0.3969	.	0.4528	11.5000
.	0.0157	0.4000	29/64	0.4531	11.5094
.	0.0197	0.5000	15/32	0.4688	11.9063
.	0.0236	0.6000	.	0.4724	12.0000
.	0.0276	0.7000	31/64	0.4844	12.3031
1/32	0.0313	0.7938	.	0.4921	12.5000
.	0.0315	0.8000	1/2	0.5000	12.7000
.	0.0354	0.9000	.	0.5118	13.0000
.	0.0394	1.0000	33/64	0.5156	13.0969
.	0.0433	1.1000	17/32	0.5313	13.4938
3/64	0.0469	1.1906	.	0.5315	13.5000
.	0.0472	1.2000	35/64	0.5469	13.8906
.	0.0512	1.3000	.	0.5512	14.0000
.	0.0551	1.4000	9/16	0.5625	14.2875
.	0.0591	1.5000	.	0.5709	14.5000
1/16	0.0625	1.5875	37/64	0.5781	14.6844
.	0.0630	1.6000	.	0.5906	15.0000
.	0.0669	1.7000	19/32	0.5938	15.0813
.	0.0709	1.8000	39/64	0.6094	15.4781
.	0.0748	1.9000	.	0.6102	15.5000
5/64	0.0781	1.9844	5/8	0.6250	15.8750
.	0.0787	2.0000	.	0.6299	16.0000
.	0.0827	2.1000	41/64	0.6406	16.2719
.	0.0866	2.2000	.	0.6496	16.5000
.	0.0906	2.3000	21/32	0.6563	16.6688
3/32	0.0938	2.3813	.	0.6693	17.0000
.	0.0945	2.4000	43/64	0.6719	17.0656
.	0.0984	2.5000	11/16	0.6875	17.4625
7/64	0.1094	2.7781	.	0.6890	17.5000
.	0.1181	3.0000	45/64	0.7031	17.8594
1/8	0.1250	3.1750	.	0.7087	18.0000
.	0.1378	3.5000	23/32	0.7188	18.2563
9/64	0.1406	3.5719	.	0.7283	18.5000
5/32	0.1563	3.9688	47/64	0.7344	18.6531
.	0.1575	4.0000	.	0.7480	19.0000
11/64	0.1719	4.3656	3/4	0.7500	19.0500
.	0.1772	4.5000	49/64	0.7656	19.4469
3/16	0.1875	4.7625	.	0.7677	19.5000
.	0.1969	5.0000	25/32	0.7813	19.8438
13/64	0.2031	5.1594	.	0.7874	20.0000
.	0.2165	5.5000	51/64	0.7969	20.2406
7/32	0.2188	5.5563	.	0.8071	20.5000
15/64	0.2344	5.9531	13/16	0.8125	20.6375
.	0.2362	6.0000	.	0.8268	21.0000
1/4	0.2500	6.3500	53/64	0.8281	21.0344
.	0.2559	6.5000	27/32	0.8438	21.4313
17/64	0.2656	6.7469	.	0.8465	21.5000
.	0.2756	7.0000	55/64	0.8594	21.8281
9/32	0.2813	7.1438	.	0.8661	22.0000
.	0.2953	7.5000	7/8	0.8750	22.2250
19/64	0.2969	7.5406	.	.8858	22.5000
5/16	0.3125	7.9375	57/64	.89063	22.6219
.	0.3150	8.0000	.	.9055	23.0000
21/64	0.3281	8.3344	29/32	.90625	23.0188
.	0.3346	8.5000	59/64	.92188	23.4156
11/32	0.3438	8.7313	.	.9252	23.5000
.	0.3543	9.0000	15/16	.93750	23.8125
23/64	0.3594	9.1281	.	.9449	24.0000
.	0.3740	9.5000	61/64	.95313	24.2094
3/8	0.3750	9.5250	.	.9646	24.5000
25/64	0.3906	9.9219	31/32	.96875	24.6063
.	0.3937	10.0000	.	.9843	25.0000
13/32	0.4063	10.3188	63/64	.98438	25.0031
.	0.4134	10.5000	1	1.000	25.40

## Fret Distance Tables

### Scale Length 604mm

distances from nut to:

fret 1	33.9
fret 2	65.9
fret 3	96.1
fret 4	124.6
fret 5	151.5
fret 6	176.9
fret 7	200.9
fret 8	223.5
fret 9	244.9
fret 10	265.0
fret 11	284.0
fret 12	302.0
fret 13	318.9
fret 14	334.9
fret 15	350.0
fret 16	364.3
fret 17	377.7
fret 18	390.4
fret 19	402.4

### Scale Length 640mm

distances from nut to:

fret 1	35.9
fret 2	69.8
fret 3	101.8
fret 4	132.0
fret 5	160.5
fret 6	187.4
fret 7	212.8
fret 8	236.8
fret 9	259.4
fret 10	280.8
fret 11	301.0
fret 12	320.0
fret 13	337.9
fret 14	354.9
fret 15	370.9
fret 16	386.0
fret 17	400.3
fret 18	413.7
fret 19	426.4

### Scale Length 648mm

distances from nut to:

fret 1	36.4
fret 2	70.7
fret 3	103.1
fret 4	133.7
fret 5	162.5
fret 6	189.8
fret 7	215.5
fret 8	239.8
fret 9	262.7
fret 10	284.3
fret 11	304.7
fret 12	324.0
fret 13	342.2
fret 14	359.3
fret 15	375.7
fret 16	390.8
fret 17	405.3
fret 18	418.9
fret 19	431.7

### Scale Length 630mm

distances from nut to:

fret 1	35.4
fret 2	68.7
fret 3	100.2
fret 4	130.0
fret 5	158.0
fret 6	184.5
fret 7	209.5
fret 8	233.1
fret 9	255.4
fret 10	276.4
fret 11	296.3
fret 12	315.0
fret 13	332.7
fret 14	349.4
fret 15	365.1
fret 16	380.0
fret 17	394.0
fret 18	407.2
fret 19	419.8

### Scale Length 645mm

distances from nut to:

fret 1	36.2
fret 2	70.4
fret 3	102.6
fret 4	133.1
fret 5	161.8
fret 6	188.9
fret 7	214.5
fret 8	238.7
fret 9	261.5
fret 10	283.0
fret 11	303.3
fret 12	322.5
fret 13	340.6
fret 14	357.7
fret 15	373.8
fret 16	389.0
fret 17	403.4
fret 18	416.9
fret 19	429.7

### Scale Length 650mm

distances from nut to:

fret 1	36.5
fret 2	70.9
fret 3	103.4
fret 4	134.1
fret 5	163.0
fret 6	190.4
fret 7	216.2
fret 8	240.5
fret 9	263.5
fret 10	285.2
fret 11	305.7
fret 12	325.0
fret 13	343.2
fret 14	360.4
fret 15	376.7
fret 16	392.0
fret 17	406.5
fret 18	420.2
fret 19	433.1